

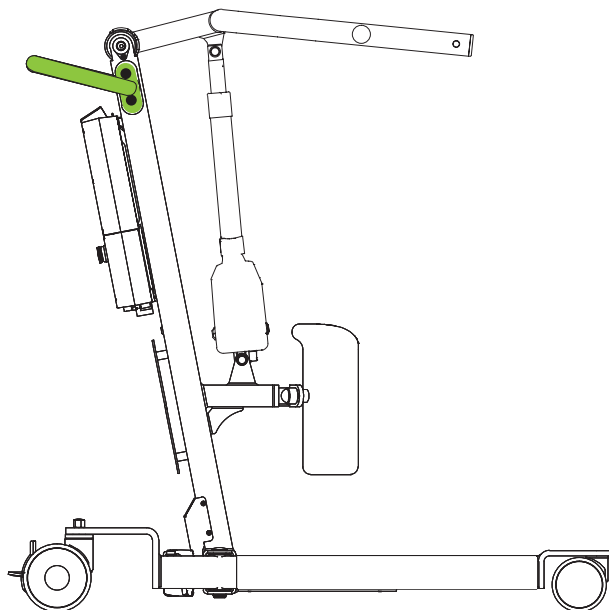

HUMAN CARE
Your Life. Your Way.



Levanto

Part no. 20000170

User Manual



Contents

User Manual (EN)

| | |
|------------------------------|----|
| Safety Instructions | 3 |
| Symbols | 3 |
| Intended Use | 3 |
| Product Benefits | 3 |
| Warnings | 4 |
| General Care and Use | 5 |
| Components | 6 |
| Technical Specifications | 7 |
| Product Label | 8 |
| Product Symbols | 8 |
| Understanding the Components | 9 |
| Usage Warnings | 13 |
| Usage Guidelines | 14 |
| Product Care | 16 |
| Troubleshooting | 17 |
| Maintenance | 17 |
| Service Checklist | 18 |

Safety Instructions



Important!

You must read the user manual for your device prior to usage. Keep this booklet and information handy for future use.

Symbols



WARNING symbol indicates a potentially hazardous situation which, if not avoided, could result in serious injury to the user or damage to property and/or the device itself.



INFORMATION symbol indicates recommendations and information for proper, trouble-free usage.



WEIGHT CAPACITY symbol indicates maximum user weight for the product. Do not exceed this weight in any circumstance.



CE MARKING symbol indicates product meets requirements of EC directives.



RECYCLE packaging according to local regulations.



READ INSTRUCTIONS and ensure you fully understand them before using this product.

Intended Use



Levanto

The Levanto is an electric sit-to-stand device that encourages a natural standing motion and is designed for standing, sitting, dressing, toileting and balance training for users with low core strength.

The Levanto can be used for transfer from the following:

- To/from a wheelchair
- To/from a toilet
- To/from a bed/stretcher

Human Care's products are continuously being developed and updated and we reserve the right to make design changes without prior notice.

Product Benefits



For the caregiver/facility

- Electronic leg spreading
- Shorter legs for easy manoeuvring
- Helps prevent caregiver injury



For the patient

- Natural motion pattern
- Ideal for rehabilitation exercises
- Non-slip footplate surface

Warnings



The decision to use this equipment must be made by a trained professional. In all cases, this product can only be articulated when the patient is attended.

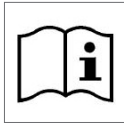

If you are unable to understand the warnings, cautions and/or instructions, contact a healthcare professional, dealer or technical personnel (if applicable) before attempting to use this equipment. Using this equipment without fully understanding it may result in injury or damage.

Warnings

DO NOT USE the product if,



Weight capacity is exceeded.

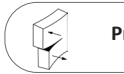

Product is damaged in any way.



The sling clips are not securely and adequately fastened.



You have not read and understood all warnings and instructions.

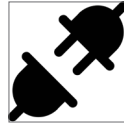

Disconnect the power supply during maintenance.



Product modification is not permitted and will void the warranty. Service and maintenance must only be done by qualified personnel.

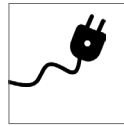

Use only the supplied power supply. Use only replacement parts supplied by Human Care.



To avoid the risk of electric shock, this equipment must only be connected to a supply main with protective earth.

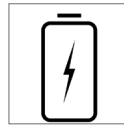

Do not touch any parts which may have leakage current and the patient simultaneously.



Maximum user weight 160kg / 352.7lb.

General Care and Use



Check the Levanto prior to each use to ensure it is not damaged in any way. Do not use if there are any signs of wear and damage on any part of the device.



Only qualified persons should use this equipment.



The Levanto should only be utilized on a hard, even and clean floor clear of any obstacles. It should never be used on an incline or decline.



Under some circumstances, more than one caregiver may be needed to assist with the patient.



Assess the patient's ability prior to using this product. Only use this product for its intended purpose.



The Levanto is designed to be used only with one patient at a time. Never use this product to lift a patient along with other furniture.



The Levanto may only be used with Human Care products.



This product is intended for indoor ambient environments. It is not intended for use in high moisture areas (i.e. showers, pool therapy), extreme temperature, humidity or pressure environments.



Facility administrator and/or risk management department should approve all patient handling protocols associated with this mobile lift prior to use.

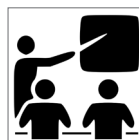

Prior to using on a patient, it is strongly recommended that training or practice with other caregivers is done until the user is comfortable with using the product.



The right type, size, material and design of accessories have been selected by a professional with respect to the client's safety and needs.

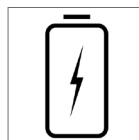

Charging of batteries should always be done in a well ventilated space. Inspect the charger regularly.

Components



- | | |
|-----------------------------|-----------------------------|
| 1. Lift Arm | 6. Front Wheel |
| 2. Push Handle | 7. Rear Wheel (with brake) |
| 3. Battery/Control Box Unit | 8. Hand Control (not shown) |
| 4. Actuator | 9. Footplate (not shown) |
| 5. Shin Pads | |

Technical Specifications

| Description | |
|--|---|
| Part no. | 20000170 |
| Width | 68.7cm / 27" |
| Length | 110cm / 43.3" |
| Height | Arm Lowered: 88.9cm / 35" Arm Raised ¹ : 164.8cm / 64.9" |
| Height (from floor) | 11.9cm / 4.7" |
| Adjustable Leg ² (Min- Max) | 67.9cm- 113.1cm / 26.7" - 44.5" |
| Sound Level | 48dB (loaded) while lifting 52dB (loaded) while spreading legs |
| IP Rating | IPX4 |
| Turning Radius | 128cm / 50.3" |
| Wheels | Front: 10cm / 4" Rear: 12.5cm / 5", with brake |
| Battery | 24V DC, 2 x 12V/2.9Ah Li-Ion accu, 24V DC/2.9Ah |
| Motor | Lifting: 24V DC, 8A max, 8kN, 10% duty cycle Spreading: 24Vdc, 2. 3A max, 1.5kN, 10% duty cycle (2x) |
| Control Box | 24Vdc, 10A max, 10% duty cycle |
| Charger | Primary: 100-240VAC50 / 60Hz, 400mA Secondary: 28.5VDC 37-53W |
| Approvals | EN60601-1, EN60601-2 |
| Weight | 49kg / 108lb |
| Weight Capacity | 160kg / 352.7lb |

¹ Measurement based on arm mast at highest setting ² Outside measurement

Product Label











The product label contains information about the device and is located on the right side, close to the mast.

This product has been tested by an accredited test institute and complies with the necessary requirements in accordance with medical requirements as follows: EN 10535, EN 60601-1 (Electrical Safety) and EN 60601-1-2 (EMC). This product is CE marked.



Product Symbols

Symbols on the unit and product label:

| | |
|---|--|
|  | CE Marking |
|  | Date of manufacture |
|  | Manufactured for Human Care |
|  | Maximum load |
|  | Instructions: Read the instructions and make sure you understand them before use |
|  | Part number/reference number |
|  | Serial number |
|  | Warning |
|  | The device contains electronics and it must be recycled appropriately |
|  | Applied part type B: approved for physical contact with patients (IEC 60601-1) |

Understanding the Components

Understanding the Hand Control

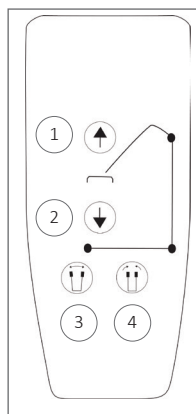

1. Arm up
2. Arm down
3. Open legs
4. Close legs

Emergency Stop



Use the emergency stop to turn off the lift when not in use to reduce the battery discharge.



Press the emergency stop button located on the side of the control box to stop the lift.



Turn the button clockwise to release the emergency stop.

Understanding the Control Box

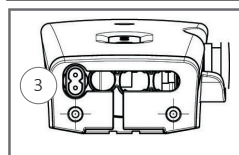
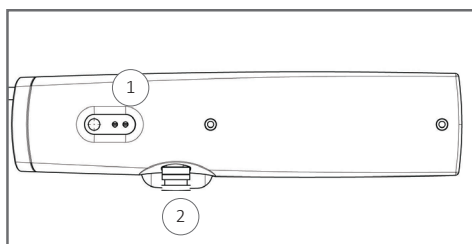

1. Control functions up/down
2. Emergency Stop
3. Mains socket

Battery



Always ensure that battery is sufficiently charged before using this lift. The battery will not charge if the emergency stop is engaged.



The battery in this device is located in the module along with the control box.

These batteries have a tamper proof seal that is located on the battery to make it easier to see if the battery has been tampered/replaced by a non-authorized person. This seal should be replaced after battery replacement.

Changing the Battery

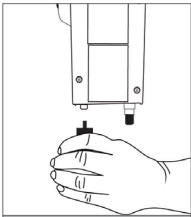

Remove all external cables from the control box. Remove from frame.

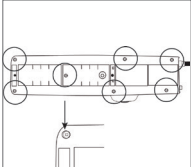

On the back side of the module, unscrew and remove the 7 torx screws on the rear of the control box/battery module to open.

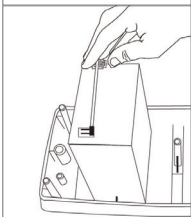

Disconnect the battery connectors and remove the old batteries.

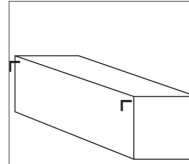

Insert the new batteries in the same direction as the old batteries, with the connectors at the top and connect (Note: += red, -= black). Be careful not to bend the connectors.

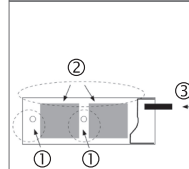

① Do not cover the holes.
② Ensure that none of the wires are squeezed or caught when reinstalling the cover.
③ Ensure the mains is not connected.

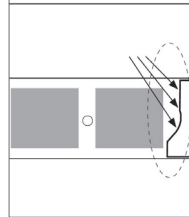

Ensure that the silicone string is in place and properly fitted before reinstalling the cover. Replace seal if necessary.



The silicone string separates the battery from the electronics and must not be damaged or modified as it will allow penetration of battery gas into the electronics components with risk of explosion. Do not use if this seal is damaged in any way.

Charging the Battery



The battery should be charged minimum 8 hours before used for the first time.

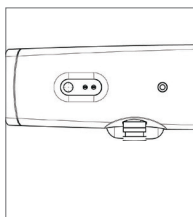

Connect the power cord to the mains to charge the battery. Make sure to disengage the emergency stop located at the side of the control box.



It is recommended that the batteries are charged at minimum once per week (depending on use). Regular charging prevents problems and extends the life of the battery.

Battery Lifespan

The number of lifting movements that can be made with a fully charged battery depends on the duration of the operation, the frequency of use, the patient weight and the age and condition of the battery.

A battery that has not been used for a long period of time will slowly drain. It is recommended that the battery is replaced every four years. These batteries have an anticipated lifespan of 2 to 4 years depending on usage.

Lifting Motor

The Levanto is equipped with a very fast, low-noise and robust motor that is designed with a ball circulation spindle, limit switches and automatic electric shut off in the event that the patient has come in contact with the arm or is sinking.

The motor is connected to the control box and allows the raising and lowering operation of the arm and the opening and closing operation of the legs. The lifting operations are performed with either the hand control (which is also connected to the control box) or from the control box itself.

Adjusting the legs



Always ensure there is sufficient space to spread the legs. If the legs get stuck, this can cause damage to the lift or the surroundings.

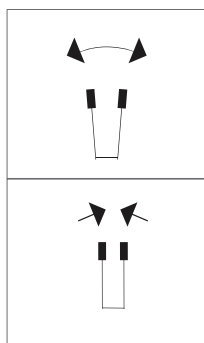

To increase leg width, press on the open button on the hand control until desired spread is achieved.

To decrease leg width, press on the close button on the hand control until desired spread is achieved.



The Levanto can be used with the legs in the wide or narrow position. The choice between which position to use depends on the necessity and available space.

Adjusting the arms



Take care when lowering or raising the arm not to hit the patient.

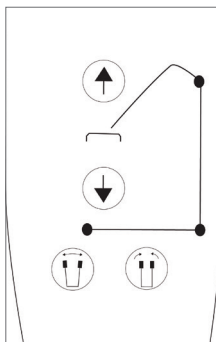

To raise the arm, press on the up arrow button. To lower, press on the down arrow button. Release to stop.

Footplate



The footplate is removable for hygiene control.



To remove, lift footplate up to clean.



Clean with a household cleaning agent or an alcohol-based detergent with a maximum ratio of 5% alcohol.

Wheels



The Levanto wheels have a very low resistance to rolling due the integrated ball bearings at the turning point.

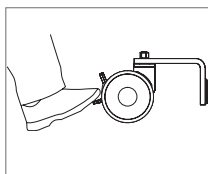

To brake, press down on the red brake lever. To release, kick up the brake lever.

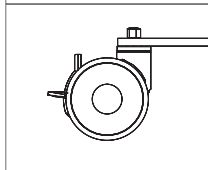

In order to ensure smooth movement, ensure the brake is in the unlocked position line up the wheels with the chassis and the direction of travel.

Shin Supports



The angle of the shin supports automatically adjusts as the mast raises. The shin pads are adjustable with a handle.

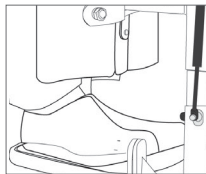

Ensure the shin pads are approximately 2cm/0.8" below the patient's knee and the front of the leg touches the shin pad without space.



Clean with a household cleaning agent or an alcohol-based detergent with a maximum ratio of 5% alcohol.

Usage Warnings

Slings



This device requires slings with clips that support the lower back.

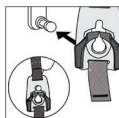

- ⚠ Affix the sling clips securely to the arms. Always test the clips before use.



- ⚠ Never place the patient on the belt as a seat and lift it up! The belt is designed to support the back under the arms.



- ⚠ This product is intended to lift one patient at a time. Never attempt to lift more than one person at a time.



- ⚠ Use only slings authorized by Human Care with this lift. Ensure the sling has been inspected for damage prior to use.



- ⚠ Do not exceed the maximum weight capacity of the sling.



- ⚠ Explain the lifting process to the patient prior to lifting. Ensure they have both the mental capability to understand and cooperate and enough muscle strength to perform the lift.

Floor Lift



Check prior to each use to ensure the Levanto is not damaged in any way. Do not use if there are any signs of wear and damage on any part of the device.

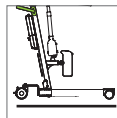

- ⚠ Use product only on a level surface. Do not use the lift on stairs, escalators or an incline/decline such as up or down a hill.

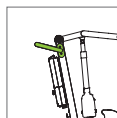

- ⚠ Use only the caregiver handles to move this lift. Using any other handles may pose a risk to both the caregiver and patient.

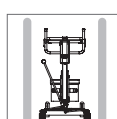

- ⚠ Great caution has to be taken when driving through tight areas such as door frames.



- ⚠ Ensure the transfer route is clear and free before commencing the lift. Move furniture and other items that may impede the transfer in any way.



If there is any concern about the condition or the proper functioning of the Levanto, always contact the technical service department or your authorized distributor.

Usage Guidelines

Initial Set Up



The Levanto is delivered ready to use and requires only minimal assembly. Check that all required components are included.

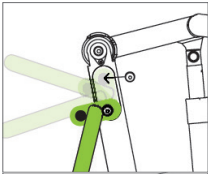

Turn the push handle upwards into the proper position as shown.

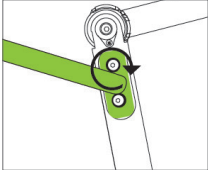

Apply Loctite to two bolts (M6x12) and insert into frame, securing handle. Turn approximately 7 turns to tighten.

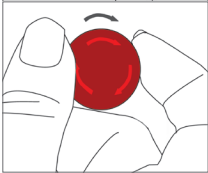

De-activate the emergency button before use (turn clockwise).

Moving the Patient



Ensure that the patient is securely held in position during the entire move. Do not move patient on an incline/decline.

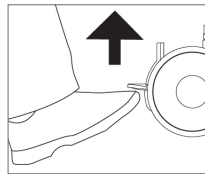

Unlock the rear casters and using the caregiver handles, move the patient as required.

Emergency Lowering



After emergency lowering is used, the lift must be serviced by an authorized technician.

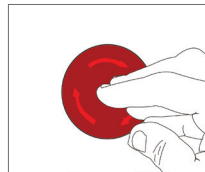

The emergency button located on the control box will interrupt and stop the lifting process. To activate press the red button.

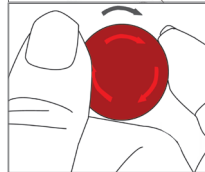

De-activate the emergency stop by turning clockwise.

Raising and Lowering the Patient



At the beginning of the lifting process, keep a hand on the sling to ensure it remains in the correct position. Lift only from a safe, seated position.



Bring the Levanto up to the patient, spreading the base as required. Place the patient's feet on the footplate and lock the rear casters.



If possible, have the patient grasp the patient handles with both hands.

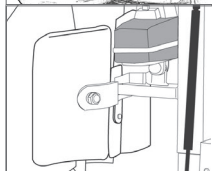

Adjust the shin pads to approximately 2cm/0.8" below the patient's knees. There should be no space between the leg and the pad.

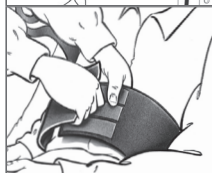

Place the sling around the patient's back and pass the ends under the patient's arms. Secure belt and tighten.

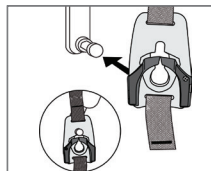

Attach sling clips to Levanto lift arm clips. Ensure all straps are even in length.

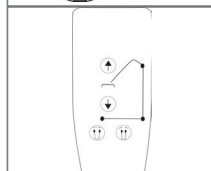

Using the up/down button raise or lower the patient approximately 2.5cm/1" to ensure the straps are secure. Continue with lift.

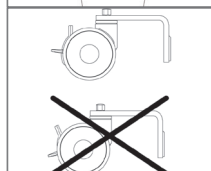

Ensure the lift brake is not engaged when seating a patient.



Ensure that if lowering patient into a product (ex. wheelchair), the brake is engaged or the seat secure.



Remove the sling only after the patient is fully seated on a firm surface.

Product Care

Lift Care



Use a clean, dry cloth or a cloth moistened with clean water and mild detergent to clean. Do not autoclave or pressure clean.



All sliding parts and moveable fittings must be lightly greased at least once per year using only an acid-free and resin-free grease.



Gloves and protective clothing should always be worn when carrying out cleaning procedures in accordance with facility guidelines.



This product can be disinfected with a 1:10 dilution of household bleach (5.25% sodium hypochlorite) as recommended by the CDC.¹ Weaker dilutions (example 1:100) may be used, but may not be in accordance with CDC recommendations.



When equipment has been used by a patient known or suspected of having an infection, this equipment must be disinfected before subsequent usage.

¹ US Department of Health and Human Services (February 1989)

Sling Care



Follow instructions on the sling label for care, or reference corresponding user manual for sling.

Troubleshooting

| Problem | Solution |
|--|---|
| The lift will not operate the up/down function. | Check that the emergency stop is off. Check that the battery is sufficiently charged. |
| The lift will not operate the open/close function. | Check that the emergency stop is off. Check that the battery is sufficiently charged. Ensure nothing is blocking the path. |
| The hand control will not work. | Check that the plug is properly inserted into the control box. Check the control box to see if the lift functions. If it is properly functioning, replace the hand control. |
| The lift will not start. | Check that the plugs are properly inserted into the control box and mains. |
| The battery is not charging. | Release the emergency stop button. |

Maintenance

The Levanto is constructed in such a way that maintenance can be kept to a minimum. It is recommended that the following maintenance scheduled is maintained.

Checklist Prior to Each Use

- ✓ Battery is fully charged
- ✓ Sling shows no signs of wear
- ✓ Plastic components i.e. clips are not cracked, damaged or worn
- ✓ Electrical lift and hand control functions checked and working
- ✓ Brakes hold position when locked

Checklist After Each Use

- ✓ Clean according to cleaning instructions.

Weekly Maintenance

- ✓ Check the operation of the lift and the operation of the emergency stop.
- ✓ Check that all parts move easily and without any noise.
- ✓ Charge the batteries.

Semi-Annual Maintenance

- ✓ Complete the service checklist. If the lift does not meet one or more of the checklist points, it should be temporarily deactivated from use until such time that it meets the maintenance criteria.

Annual Maintenance

- ✓ Once a year, according to ISO 10535, the lift must be inspected. This inspection must be done only by qualified and authorized personnel. Each lift shall have a service control sticker affixed indicating the date of inspection.



Service Checklist: Levanto

| Inspection Checklist | | | |
|--|--------------------------|---------------|---------------------|
| Semi-Annual Check | Annual Check | Serial Number | Date |
| <input type="checkbox"/> | <input type="checkbox"/> | | |
| Visual Check | Good | Unacceptable | Additional Comments |
| The serial number sticker is present and legible. | | | |
| The manual or quick reference guide is available for reference. | | | |
| The annual service sticker is present and legible. | | | |
| The lift and its accessories do not have any visible damage or wear. | | | |
| All components are present eg. battery. | | | |
| There is no wear on the cables / wires. | | | |
| There is no damage to the chassis. | | | |
| Operation | | | |
| The emergency stop is functioning. | | | |
| The control box is functioning. | | | |
| The hand control is functioning. | | | |
| The lift operates smoothly and without excess noise. | | | |
| The wheels roll smoothly. | | | |
| The wheel brake functions properly. | | | |
| The battery is fully loaded and there is no damage to the charger. | | | |

Checked by:

Next service date:

Note: This service checklist may be copied for future checks.



HUMAN CARE
Your Life. Your Way.